

Products: SMIQ - Vector Signal Generator

Level Accuracy and Electronic Level Settings of SMIQ

Application Note

Most signal generators are equipped with a mechanical attenuator. Those attenuators are exposed to mechanical stress due to mechanical switching. To avoid mechanical stress on the attenuator the SMIQ is additionally equipped with two electronic attenuator functions that provide level settings without degrading attenuator performance and without exposing the attenuator to mechanical stress. These functions are especially useful in production and production testing where frequent level setting is necessary.



Contents

1	Overview.....	2
2	Attenuator Modes	5
	ATTENUATOR MODE AUTO (Default Mode)	5
	ATTENUATOR MODE FIXED	6
	ATTENUATOR MODE ELECTRONIC	7
3	ALC Modes.....	8
	ALC MODE AUTO (Default Mode).....	8
	ALC MODE ON	8
	ALC MODE OFF → SAMPLE & HOLD	9
	ALC MODE OFF → TABLE.....	9
4	Level Settings – Manually and Via GPIB Commands	10
5	Level Linearity of SMIQ	13
6	Level Stability and Setting Repeatability.....	17
7	UCOR Mode in SMIQ for User Correction Functionality	19
8	References	21
9	Ordering Information.....	21

1 Overview

The Vector Signal Generator SMIQ from Rohde & Schwarz is equipped with a mechanically switched attenuator and two additional devices for electronic level attenuation. The automatic interaction between these three devices ensures best RF-level accuracy, stability and linearity.

Besides the automatic mode the user can choose the level setting mode which is best suited for his application. For instance an operating mode can be selected where the mechanically switched attenuator is not in operation and level setting is performed by the electronic attenuators. The purely electronic level setting capability of the SMIQ with a dynamic range of up to 90 dB has the advantage of working without wear and tear. This is an important aspect when using the SMIQ in a production test environment, where millions of level settings have to be carried out.

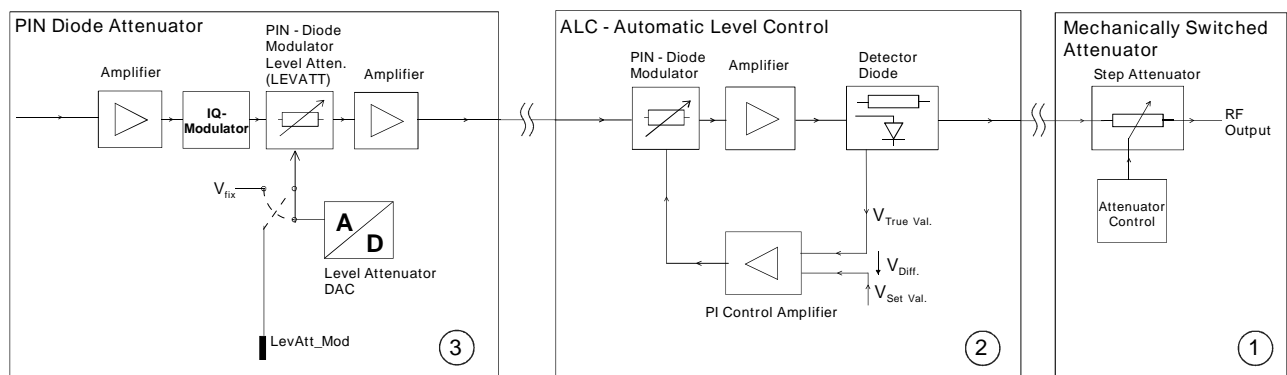

Fig. 1-1 The three modules to perform level settings in the SMIQ.

Level Accuracy and Electronic Level Settings

There are three modules which perform level settings in the SMIQ:

- ① The mechanically switched attenuator is connected between the RF-output module and the instrument output. The mechanical concept uses six in series cascaded, fixed attenuator pads. Some characteristics of this attenuator type are:
 - Switching between attenuator pads occurs in 5 dB steps.
 - Level attenuation range of 135 dB (5 dB steps).
- ② The automatic level control (ALC) is located prior to the mechanically switched attenuator ① in the signal path of the SMIQ. Its characteristics are:
 - Electronic level attenuation in 0.1 dB or 0.01 dB steps resolution.
 - Level attenuation range of 25 dB (linear range).
 - The ALC fulfills three different tasks:
 1. Level setting.
 2. Keeping the level constant over temperature and time.
 3. Amplitude modulation (AM), by varying the set value ($V_{\text{Set Val.}}$, Fig. 1-1).
- ③ The PIN-diode attenuator is located after the IQ Modulator and has the following characteristics:
 - Electronic level attenuation in 0.1 dB or 0.01 dB resolution.
 - Level attenuation range of 70 dB.

In the SMIQ, one can choose between three attenuator modes to *set* the RF-output level. The modes are:

- ATTENUATOR MODE AUTO (default mode)
- ATTENUATOR MODE FIXED
- ATTENUATOR MODE ELECTRONIC

When ATTENUATOR MODE AUTO is set, the mechanically switched attenuator is active. The other two modes do level attenuation electronically. A detailed explanation of the three attenuator modes is given in section 2.

In addition, four ALC modes are settable to *keep* the RF-level at the desired value.

The control modes are:

- ALC MODE AUTO (default mode) - The ALC mode is automatically set to ON or OFF accordingly to modulation settings.
- ALC MODE ON
- ALC MODE OFF → SAMPLE & HOLD
- ALC MODE OFF → TABLE

So, in total there are $3 \times 4 = 12$ different possible configurations for level setting and control. As setting and control methods are not totally independent of each other, not every combination is possible or sensible.

Level Accuracy and Electronic Level Settings

An overview of the combinations is given in the table below. The ALC mode AUTO has been left out, because it always results in one out of three listed modes being active.

	<i>Attenuator Mode AUTO</i>	<i>Attenuator Mode FIXED</i>	<i>Attenuator Mode ELECTRONIC</i>
ALC mode ON	possible	possible	not possible
ALC mode OFF SAMPLE & HOLD	possible	not recommended* * Setting this mode will issue a warning message. It is recommended, to use ALC-OFF – TABLE. This mode is not completely a non-interrupting mode (explanation, see SAMPLE & HOLD respectively TABLE mode)	not possible
ALC mode OFF TABLE	possible	possible	possible

Sections 2 and 3 give a brief overview of the attenuator modes and the ALC modes. The principle operation of the different attenuator and control modes is given as well as its advantages and disadvantages are described. Section 4 explains how these modes can be set in SMIQ either manually or using GPIB commands. Section 5 includes some typical measurement results for level linearity. Section 6 demonstrates level stability of the SMIQ for two commonly used digital radio communication standards. Section 7 describes UCOR mode, where user defined correction values for the RF-level can be set.

2 Attenuator Modes

ATTENUATOR MODE AUTO (Default Mode)

The ATTENUATOR MODE AUTO, represents the standard mode of operation of the SMIQ.

The attenuation of the mechanically switched attenuator (see Fig. 1-1, circuit block ①) is automatically selected in accordance with a user's set RF-level. Switching of the attenuator occurs in 5 dB steps. The intermediate steps of attenuation are set by the ALC loop in the SMIQ (see Fig. 1-1, circuit block ②). The ALC loop operates within this mode in a range between 0 dB and 4.9 dB.

ADVANTAGES:

- Best level accuracy and best level linearity over the entire range of 135 dB when compared to the other modes.
- Smallest time or temperature drift over the entire RF-level range.
- High degree of level stability due to small insertion loss and high temperature stability. Most stable mode of all modes.
- RF-level can be varied over a large frequency range having a small level deviation.
- Minor total level uncertainty¹.

DISADVANTAGES:

- The mechanically switched attenuator is affected by wear and tear.
- Level setting time is not as fast as for the two other attenuator modes. The total level setting time for the mechanical attenuator is specified as <25 ms, typically 16 ms.
- The RF-output level of the SMIQ is blanked while a new level is set. This has various reasons:
 - opening or closing the mechanical contacts of the attenuator pads may cause contact bounce.
 - switching between attenuator pads can lead to power spikes and oscillations of the RF-output level.

In order to prevent these effects at the RF-output the RF-level is at most attenuated for a period of 15 ms.

¹ The SMIQ data sheet specifies for a total level uncertainty for a RF-Level of >- 127 dBm:

f≤2 GHz	<0.5 dB
f>2 GHz to 4 GHz	<0.9 dB
f>4 GHz to 6 GHz	<1.2 dB

ATTENUATOR MODE FIXED

In this mode the mechanical switched attenuator is kept fixed in its current position once selected, and the level is set electronically using the ALC control loop. The level attenuation is done in a range of 0 dB to about -25 dB relative to the RF-level at the time when ATTENUATOR MODE FIXED was switched on.

The SMIQ indicates the range of possible output levels for the ATTENUATOR MODE FIXED in the ATTEN FIXED RANGE. The range of variation is fixed automatically upon mode selection. For example if a level of -10 dBm is set as reference level (set either in the submenu section AMPLITUDE or directly in the LEVEL display in Fig. 2-1), the ATTEN FIXED RANGE will show a span of -33 dBm to -10 dBm.

ADVANTAGES:

- Very fast level setting capability: level setting time <2.5 ms.
- No mechanical wear and tear.
- Non-interrupting level setting.
- Best suited to test squelch limits.

DISADVANTAGES:

- Restricted dynamic range of about 25 dB (when compared to ATTENUATOR MODE ELECTRONIC).
- In case of over or under ranging of the normal variation range, level errors strongly increase.
- The noise floor degrades the spectral purity of the output signal at high attenuation values.

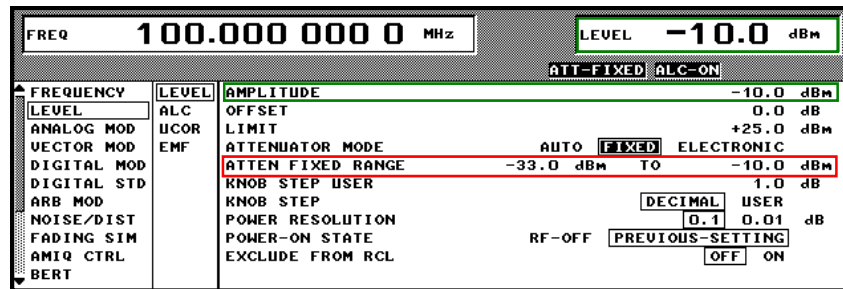

Fig. 2-1 The attenuator fixed range of the ATTENUATOR MODE FIXED is displayed in the ATTEN FIXED RANGE submenu section. Submenu section AMPLITUDE and LEVEL display, indicate the reference level for the ATTENUATOR MODE FIXED.

ATTENUATOR MODE ELECTRONIC

The ATTENUATOR MODE ELECTRONIC² uses the level attenuation circuit located at the output of the IQ Modulator (see Fig. 1-1, circuit block ③). The signal is applied to two pin diode attenuators, which are separated by an amplifier. This allows a fast level attenuation transient time of <15 µs and an attenuation of up to 70 dB. For level settings requiring an attenuation of more than 70 dB the automatic level control circuitry is automatically used in addition, so that a total dynamic range of 90 dB electronic level setting is achieved.

The range of variation is fixed automatically upon mode selection. The range is indicated in the ATTEN FIXED RANGE section (see Fig. 2-2).

ADVANTAGES:

- Very fast level setting capability: level setting time <2.5 ms.
- No mechanical wear and tear.
- Non-interrupting level setting range of 90 dB.

DISADVANTAGES:

- Restricted dynamic range of 90 dB.
- In case of over or under ranging of the normal variation range, level errors strongly increase.
- The noise floor and the from the noise floor arising spurious emissions degrade the spectral purity of the output signal at high attenuation values.
- Reduced temperature stability.

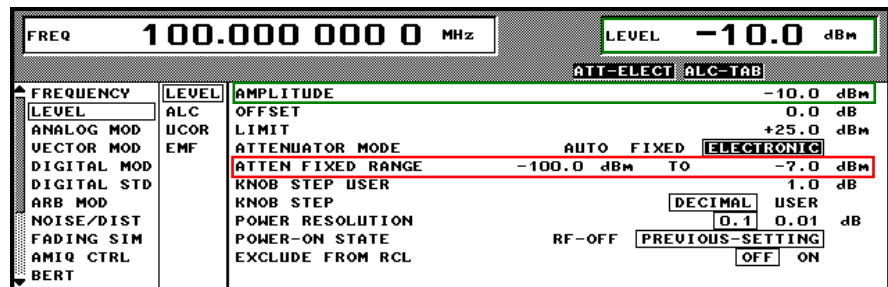

Fig. 2-2 The attenuator fixed range displayed in subsection ATTEN FIXED RANGE of the ATTENUATOR MODE ELECTRONIC.

² This function is only available if the IQMOD module version VAR 4 or later is installed (indication in UTILITIES - DIAG -CONFIG menu, IQMOD Var 4 required).

3 ALC Modes

The ALC (Fig. 3-1) holds the output power at the desired level in spite of drift due to temperature and time.

ALC MODE AUTO (Default Mode)

In ALC MODE AUTO, the ALC state is automatically adopted to the operation condition of the SMIQ. In CW, AM and FM (ϕ M), the ALC is switched on so that an optimum level accuracy is obtained. For vector modulation or digital modulation, the ALC is in general switched off. In this case the level control is set automatically either to SAMPLE & HOLD or TABLE mode.

ALC MODE ON

This mode forces the ALC to be active (switched ON), independent of modulation settings.

ADVANTAGES:

- Closed loop control.
- Useful for digital modulations or vector modulations with constant envelope characteristics such as Gaussian Minimum Shift Keying (GMSK) and Frequency Shift Keying (FSK).
- Best suited for all analog modulations.
- Smallest time or temperature drift of all control modes.
- Good repeatability.

DISADVANTAGES:

- Not useful for digital and vector modulations without constant envelope characteristics, e.g. Quadrature Phase Shift Keying QPSK.
- Degradation of digital modulation.
- IM3 performance reduced at high output levels.

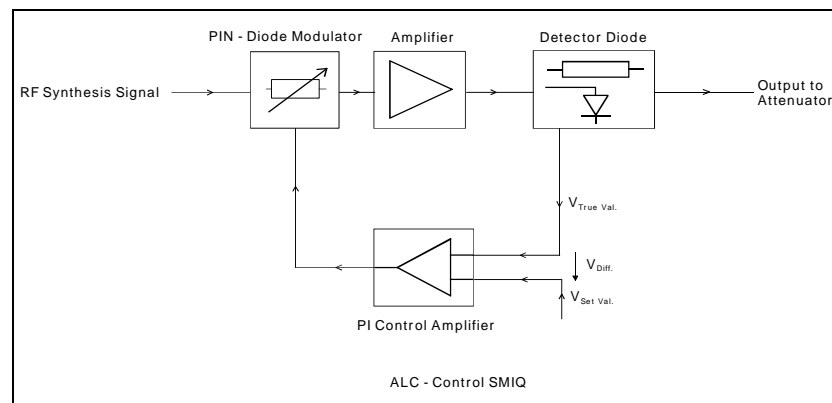

Fig. 3-1 The ALC circuit.

ALC MODE OFF → SAMPLE & HOLD

In SAMPLE & HOLD mode the SMIQ re-calibrates the level after each change of level respectively frequency. The SMIQ switches for a short period into CW mode, and then activates the ALC, the ALC stabilizes the level to the set value ($V_{\text{Set Val.}}$, Fig. 3-1), and the SMIQ holds the level and switches the ALC off again. As an additional function the SMIQ offers a command called SEARCH ONCE ► to force the SMIQ to do the re-calibration if the SAMPLE & HOLD mode is active.

ADVANTAGES:

- Useful for improving the intermodulation suppression in multi-signal measurements in CW mode.
- Immediate level correction possible, due to re-calibration of the currently set level and not the entire level setting range of this mode.
- Enhanced IM3 performance.
- No degradation of digital modulations.

DISADVANTAGES:

- Affected by time and temperature drifts. No closed loop control.
- Does not present a completely non-interrupting level setting mode. The SAMPLE & HOLD mode switches into CW operation and activates the ALC in order to correct level deviations.
- Degradation of level setting repeatability, which is caused by the resolution of the level DAC.

ALC MODE OFF → TABLE

If the calibration procedure of the ALC performed in SAMPLE & HOLD is not desired, the TABLE mode is available. In TABLE mode for each change in level respectively frequency an attenuation settings value is taken from a table, which is saved in memory, and the level is adjusted accordingly to the table value. Level attenuation between two table values is done by means of linear interpolation. The table can be re-generated at any time during operation if LEARN TABLE ► is selected from the menu.

Note: *The table is generated internally without the use of any external test equipment. Once a user calls the LEARN TABLE ► function, a new table is immediately created and saved in memory. The table is valid for the entire RF-level range. It is not required to call the LEARN TABLE ► function every time a new level has been set. However, it is recommended to do a re-calibration by executing the LEARN TABLE ► function if temperature variations exceed 5 °C.*

ADVANTAGES:

- Represents true non-interrupting level setting capability when the instrument runs in one of the electronic attenuator modes. (ATTENUATOR MODE FIXED and ATTENUATOR MODE ELECTRONIC).
- Enhanced IM3 performance.
- No degradations of digital modulations.
- Uses table values for setting level attenuation. This mode is not affected by degradation of level setting repeatability caused by the level DAC.

DISADVANTAGES:

- Affected by time and temperature drifts. No closed loop control.
- Re-calibration is necessary if temperature variations exceed 5 °C.
- May need re-calibration if the instrument has not been used for a longer period of time.
- Interpolation errors may degrade the level accuracy.

4 Level Settings – Manually and Via GPIB Commands

The different **attenuator modes** can be found in the LEVEL-LEVEL menu.

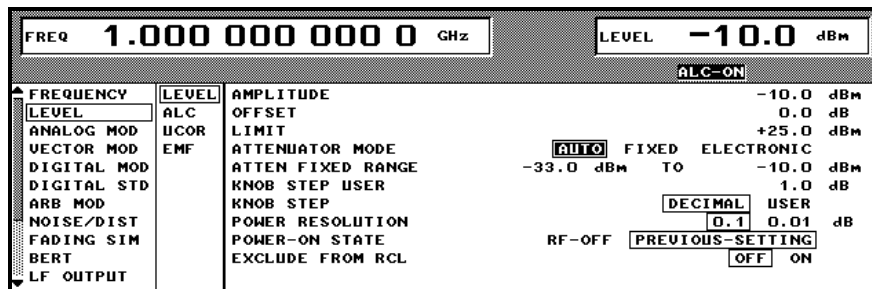

To activate the ATTENUATOR MODE AUTO:

- Scroll to the LEVEL menu in the main menu.
- Select LEVEL twice with the select button.
- Scroll down to ATTENUATOR MODE and select AUTO.

The ATTENUATOR MODE AUTO is now active and the mechanical attenuator is in operation. The ALC-ON annunciator will indicate the active state of this mode.

IEC/IEEE bus command:
:OUTP:AMOD AUTO

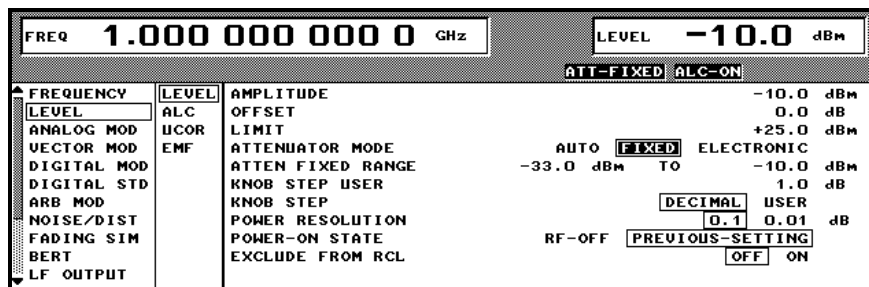

To select ATTENUATOR MODE FIXED:

- Select in ATTENUATOR MODE → FIXED.

The ATTENUATOR MODE FIXED is active and level settings are done electronically via the ALC loop. The ALC-FIXED annunciator will be displayed. Next to it the level control mode is shown.

IEC/IEEE bus command:
:OUTP:AMOD FIX

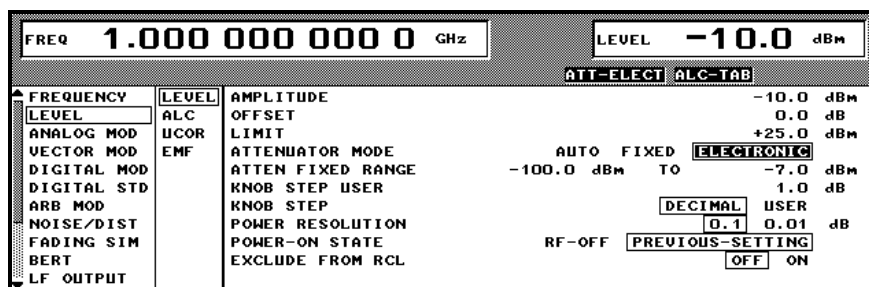

To get to the ATTENUATOR MODE ELECTRONIC:

- Select in ATTENUATOR MODE → ELECTRONIC.

The ATTENUATOR MODE ELECTRONIC is active and level settings are done electronically via the level attenuation circuit located after the IQ Modulator and the ALC circuit located before the mechanical attenuator. You will see the ALC-ELECT annunciator in the upper half of the display. Also the level control mode will be visible.

IEC/IEEE bus command:
:OUTP:AMOD ELEC

Level Accuracy and Electronic Level Settings

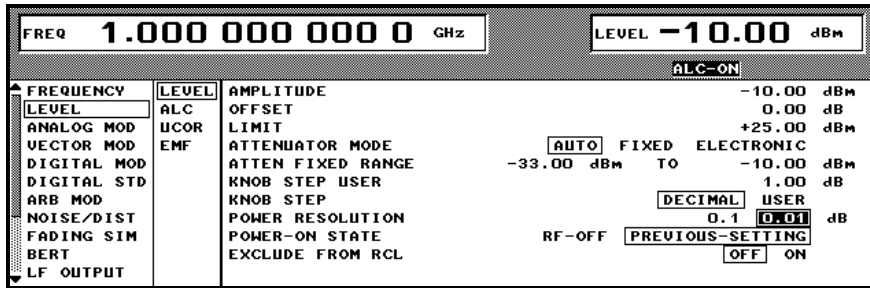

To set the **level resolution** in the SMIQ:

- Scroll down to **POWER RESOLUTION** and change from 0.1 dB (default resolution) to 0.01 dB to have a finer level resolution set in the SMIQ

In the level display you see how the resolution will change from e.g. -10.0 dBm to -10.00 dBm.

In order to set the different **ALC modes** available in the SMIQ, change from **LEVEL-LEVEL** menu to the **LEVEL-ALC** menu.



To set the ALC AUTO Mode:

- Scroll to the **LEVEL** menu in the main menu.
- Select **LEVEL** with the select button and scroll down to **ALC**, acknowledge with select.
- In the **STATE** submenu select **AUTO**.

The **AUTO** mode in the ALC menu is the default mode. The ALC mode for level settings is automatically selected by the instrument, dependent on the attenuator mode and modulation type selected by the user.

The ALC mode, which is currently active, can be seen by the annunciator in the upper part of the screen, e.g. **ALC-ON**.

IEC/IEEE bus command:
:SOUR:POW:ALC AUTO



To force the SMIQ to set the ALC to **ON**:

- In the **STATE** submenu select **ON**.

The SMIQ will now activate the ALC and forces the ALC to be **ON** independent of the set attenuator mode or the activated modulation type. However, some of the modulation types and attenuator modes do not work with ALC **ON**. Here the SMIQ will issue a warning message and the mode can not be set.

The **ALC-ON** annunciator is activated.

IEC/IEEE bus command:
:SOUR:POW:ALC ON

Level Accuracy and Electronic Level Settings

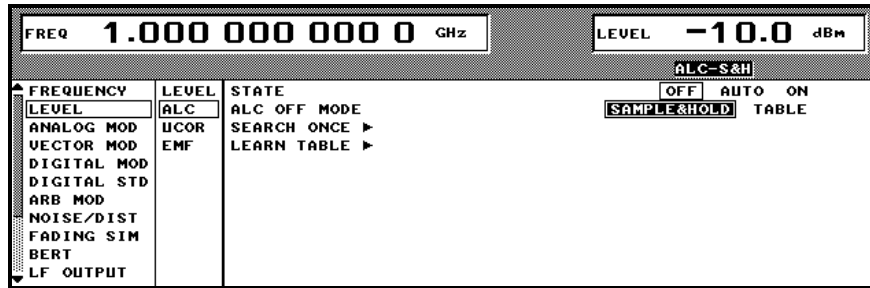

To activate SAMPLE & HOLD mode:

- Switch STATE to OFF.
- Scroll down to ALC OFF MODE.
- Select SAMPLE & HOLD.

In general SAMPLE & HOLD is selected (default mode). The state, that SAMPLE & HOLD is active, is shown with the ALC-S&H annunciator in the upper half of the display.

IEC/IEEE bus command:

```
:SOUR:POW:ALC OFF
:SOUR:POW:ALC:SEAR ON
```

With the SEARCH ONCE ▶ function, it is possible to force the SMIQ to do a re-calibration of the currently set RF-level, in CW mode using the ALC, in hold the new calibrated RF-level.

IEC/IEEE bus command:

```
:SOUR:POW:ALC:SEAR ONCE
```

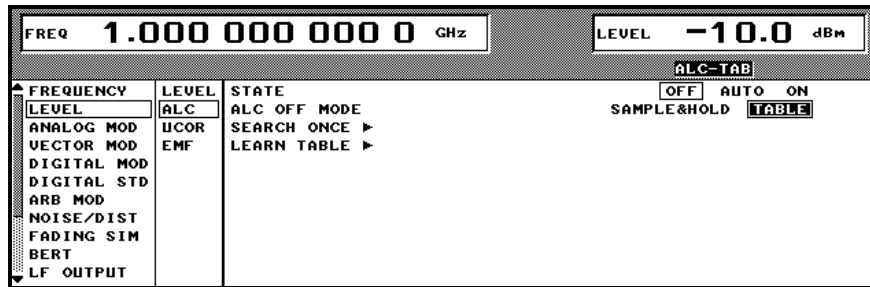

To get to TABLE mode:

- Switch STATE to OFF.
- Select TABLE in the ALC OFF MODE submenu.

The ALC-TAB annunciator will be visible and state that the ALC - TABLE mode is active.

IEC/IEEE bus command:

```
:SOUR:POW:ALC OFF
:SOUR:POW:ALC:SEAR OFF
```

It is possible to force the SMIQ to re-calibrate and create a new table with the LEARN TABLE ▶ function. This is especially useful and recommended if temperature variations exceed 5 °C.

IEC/IEEE bus command:

```
:SOUR:POW:ALC:TABL:MEAS?
```

5 Level Linearity of SMIQ

To show the difference between various attenuator and ALC modes here are some measurements from a Rohde & Schwarz SMIQ03B.

All measurements presented in this section have been performed stepping the generator's RF-level in 2.5 dB steps and measuring the deviation from the reference level at 9 dBm respectively at 10 dBm with the highly linear digital IF of a Rohde & Schwarz Signal Analyzer FSIQ.

The level deviation from the reference level was measured at four different frequencies: 89 MHz, typically used for analog radio broadcasting, 900 MHz for the cellular phone communication standard GSM, 1900 MHz (PCS band) and 3.3 GHz, which represents the maximum frequency range of the SMIQ03B.

Attenuator Mode Auto

Fig. 5-1 shows the measured deviations. The generator is set in ATTENUATOR MODE AUTO and ALC MODE AUTO. The measurement includes all attenuator steps (fixed attenuators) of the mechanically switched attenuator. All four traces in Fig. 5-1 show total level deviations within a range of ± 0.15 dB. At around -120 dBm the level shows the largest deviations. Here the FSIQ is in or close to the noise floor which contributes to the larger deviations at this low level.

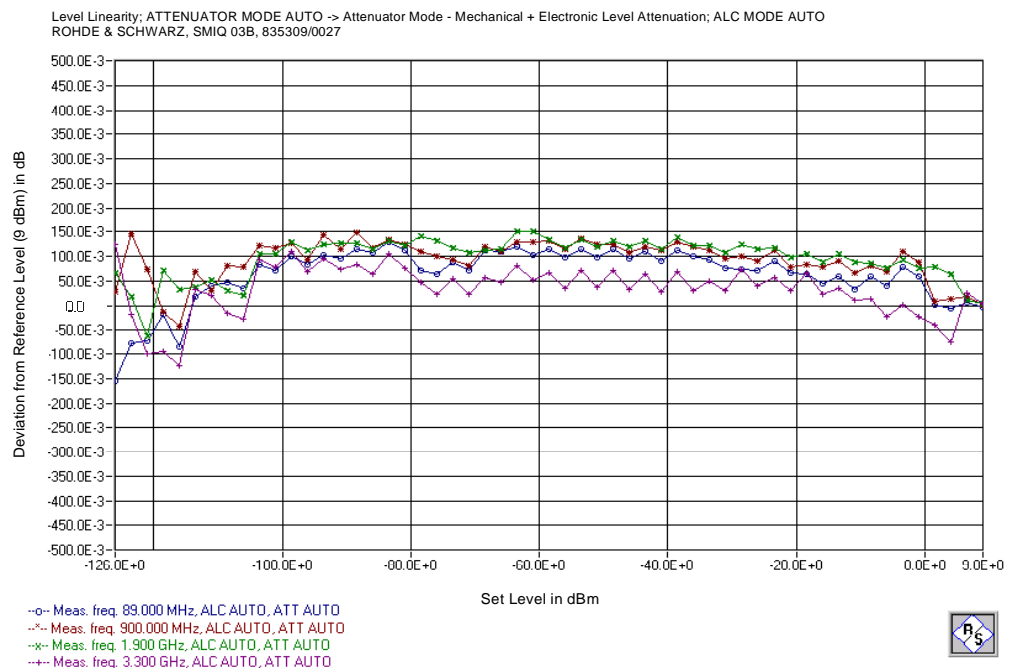

Fig. 5-1 The deviation measured from the reference level at 9 dBm for the mechanical attenuator. The measurement includes all attenuator steps of the mechanically switched attenuator. The four traces show the deviations from reference level (9 dBm) at four different frequencies.

When using the ATTENUATOR MODE AUTO and ALC MODE OFF SAMPLE & HOLD as presented in Fig. 5-2, the deviations are slightly larger, compared to Fig. 5-1 because the input voltage of the ALC has to be measured and restored. Here the resolution of the measuring ADC (12-bit resolution) and the level DAC play a role. Reproducibility is not as good as for the ALC ON mode, where the same level settings always produce the same DAC settings.

Level Accuracy and Electronic Level Settings

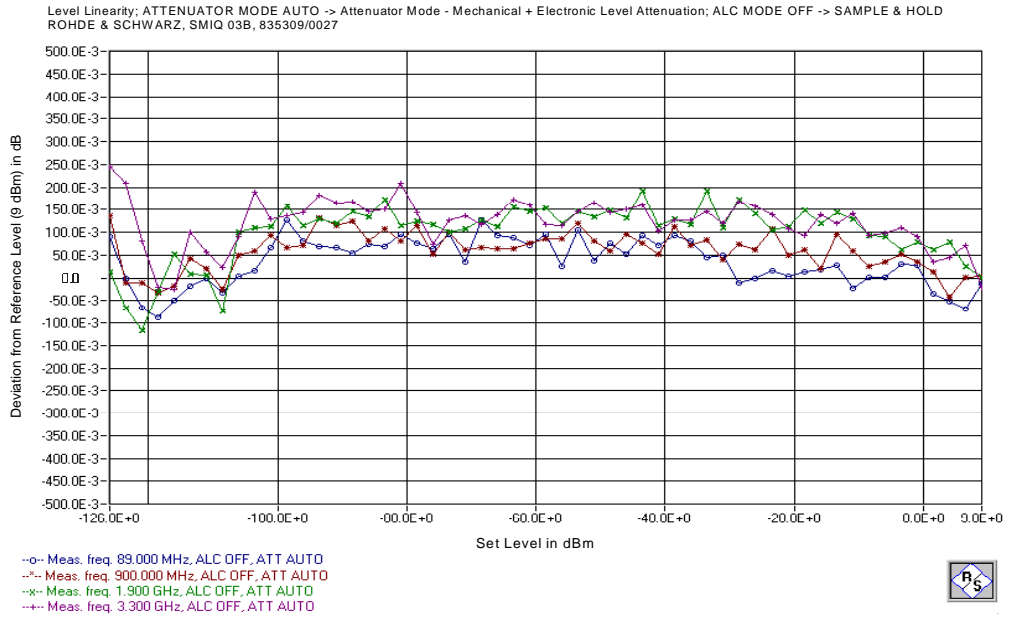

Fig. 5-2 The level deviation in ATTENUATOR MODE AUTO and ALC MODE OFF SAMPLE & HOLD.

Attenuator Mode Fixed

In ATTENUATOR MODE FIXED and ALC AUTO (Fig. 5-3), level deviations are within 0.25 dB, which represents an excellent linearity in the entire range of this attenuator mode (setting range of about 25 dB).

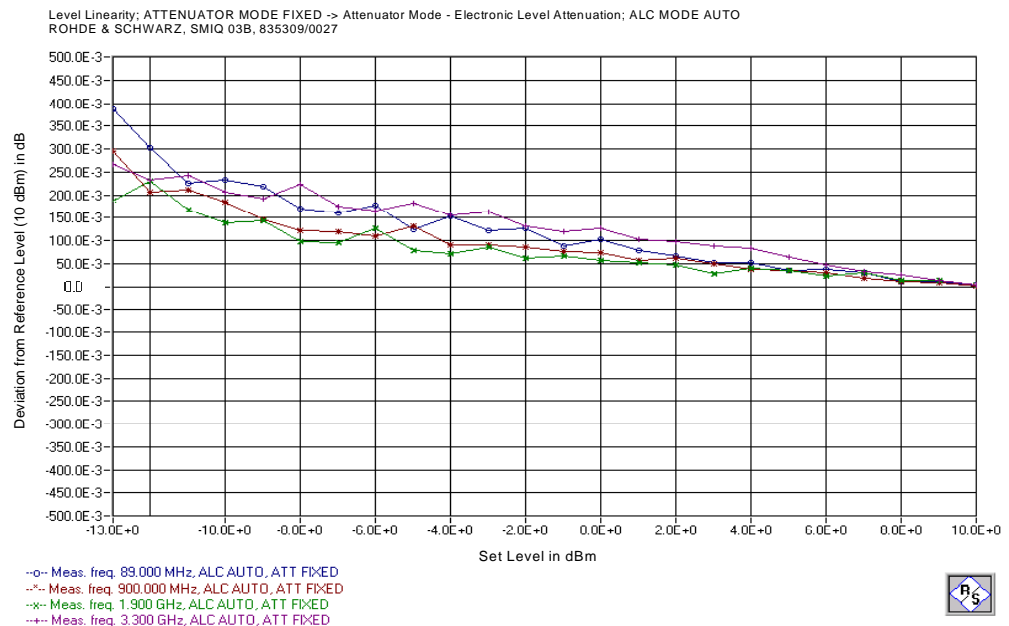

Fig. 5-3 The level linearity is excellent when SMIQ is operated in ATTENUATOR MODE FIXED and ALC AUTO. The level deviations are of the order of 0.25 dB related to the reference level.

Level Accuracy and Electronic Level Settings

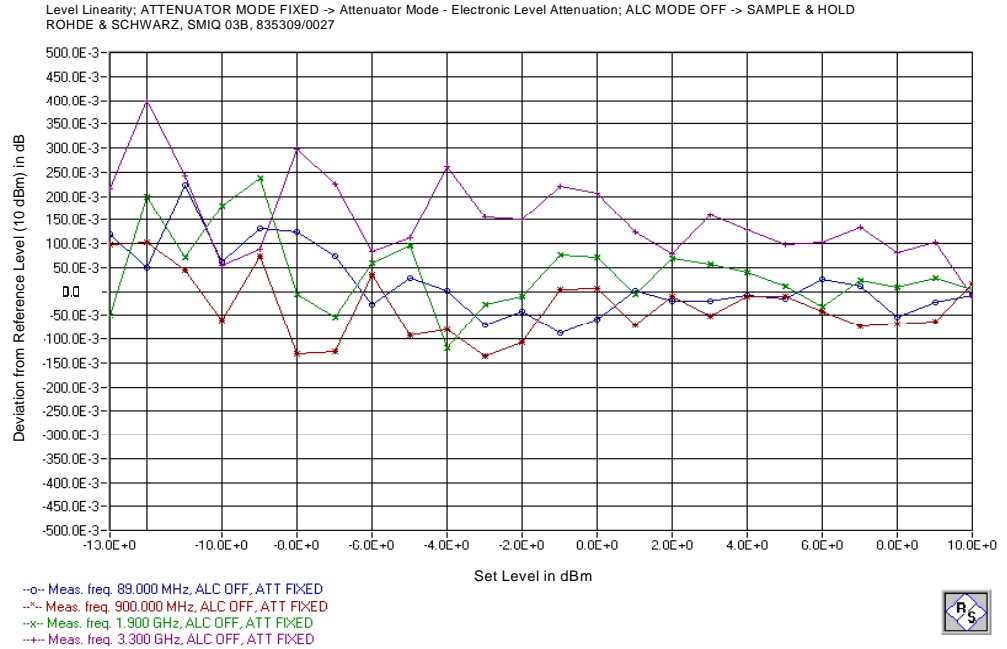

Fig. 5-4 The level deviation increase slightly when SMIQ is operated in ATTENUATOR MODE FIXED, ALC OFF MODE SAMPLE & HOLD. However, level deviations are still below 0.5 dB.

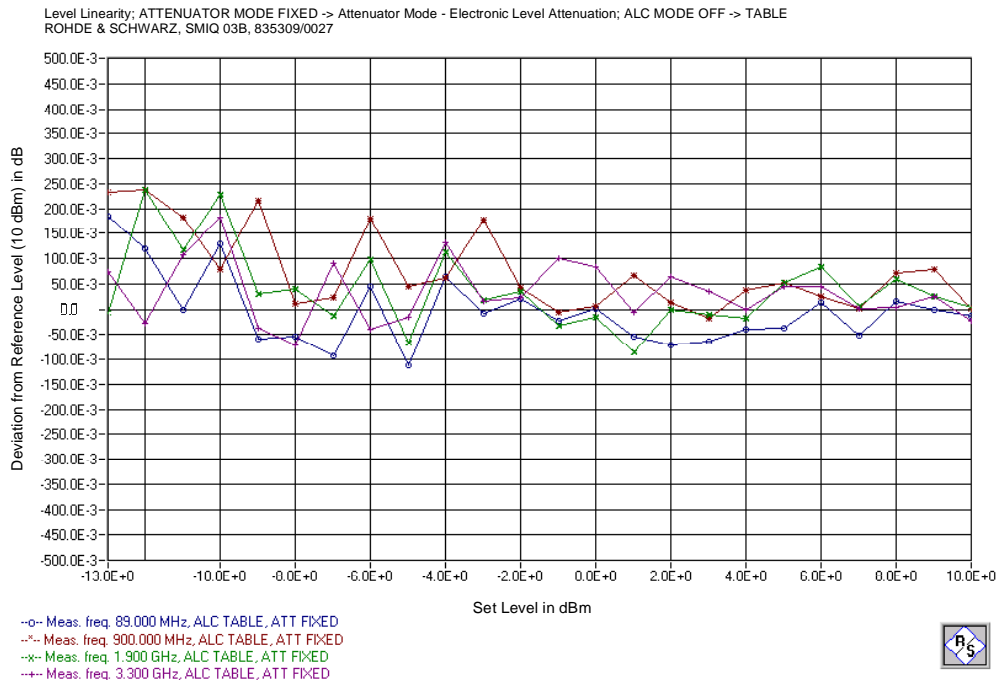

Fig. 5-5 Level deviations from reference level (10 dBm) for ATTENUATOR MODE FIXED, ALC OFF MODE TABLE.

Fig. 5-4 and Fig. 5-5 show the ATTENUATOR MODE FIXED, when the automatic level control is switched off (ALC MODE OFF). Measurements have been carried out for both ALC OFF modes, ALC OFF SAMPLE & HOLD and

Level Accuracy and Electronic Level Settings

ALC OFF TABLE. Level deviations are not as good as with ALC ON, but still below 0.5 dB.

Attenuator Mode Electronic

In Fig. 5-6 the SMIQ is in ATTENUATOR MODE ELECTRONIC. The measurement is performed by stepping the SMIQ through the full dynamic range of 90 dB. The ALC MODE switches automatically into the ALC OFF MODE TABLE and uses table values for the attenuation. The level deviations are not as good as for the mechanical attenuator (Fig. 5-1). However, the deviations do not exceed 0.6 dB in total in the entire dynamic range (-84 dBm, 10 dBm). The attenuator is calibrated internally using the diagnosis detector of the PIN diode attenuator situated after the IQ modulator. The resolution of the DAC of the PIN diode attenuator and interpolation uncertainties limit the level adjustment accuracy. The total level uncertainties are not as good as for the ATTENUATOR MODE AUTO and ALC MODE ON (Fig. 5-1).

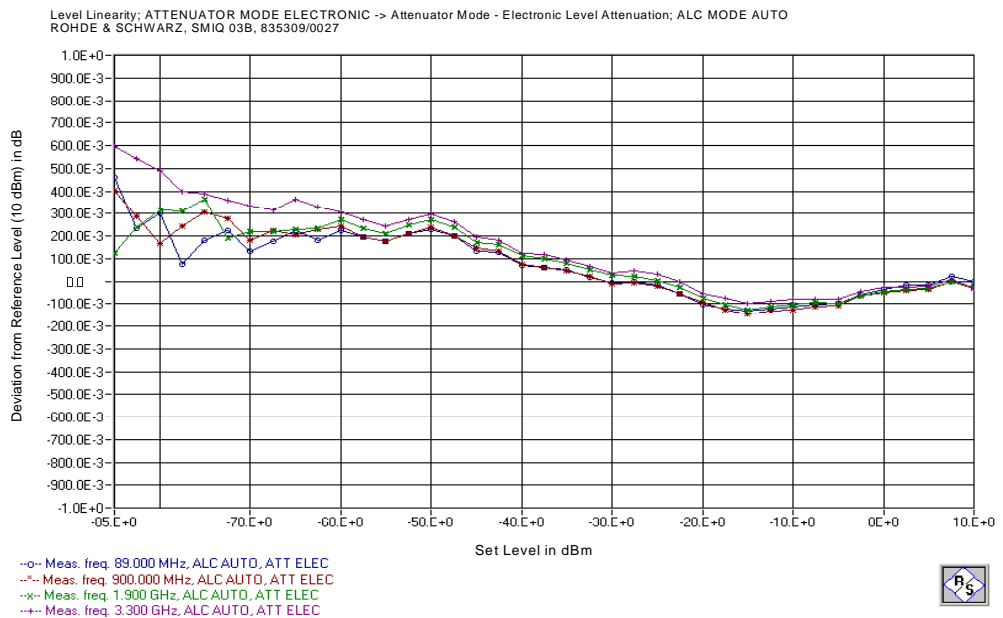

Fig. 5-6 The level deviation in ATTENUATOR MODE ELECTRONIC measured over the full dynamic range of 90 dB.

6 Level Stability and Setting Repeatability

To demonstrate the effect of level stability, the next two charts represent level deviations from nominal RF-levels, when the generator is repeatedly set back to the nominal level from a randomly selected level position. The nominal level has been set at SMIQ and measured with a calibrated Rohde & Schwarz power meter NRVD. Every 30 seconds the RF-level has been randomly attenuated and then re-set to the nominal level position. Measurement samples were taken constantly for a duration of 2 hours. This has been done for two commonly used digital modulation standards, GSM and W-CDMA.

Fig. 6-1 displays the level stability of a GSM modulated signal. To identify correctly the level stability, measurements have first been performed in CW mode with the ALC switched ON to measure the deviation from the nominal level and to see the stability of the level in time when the ALC is in operation. The nominal level was set to 0.2 dBm and the frequency was set to 900 MHz in accordance with the GSM standard. The stability of the CW signal in the graph is constant at a level of 0.16 dBm. The ALC is constantly controlling the RF-level and instantly corrects existing level deviations from the nominal level. If GSM modulation is switched on and the ALC MODE is switched to OFF SAMPLE & HOLD the repeatability of level settings deteriorates, resulting in two different output levels with a difference of about 0.1 dB. This is due to the last bit set in the level DAC. If the particular bit in the DAC flips from 1 to 0 or vice versa.

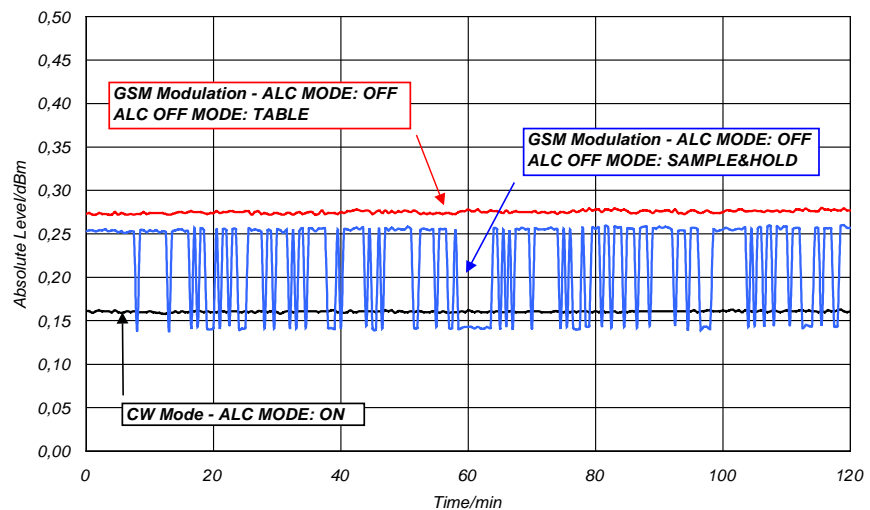

Fig. 6-1 The level stability of a GSM signal. As a reference a CW signal has been measured first in order to show the level stability of the ALC circuit. The other two ALC modes operate with the GSM modulated signal.

In ALC OFF MODE TABLE there is no deterioration of setting repeatability. Therefore, this mode is better than SAMPLE & HOLD mode if repeatability is most important. On the other hand ALC OFF MODE TABLE may need re-calibration if temperature variations exceed 5 °C, which is not necessary for ALC OFF MODE SAMPLE & HOLD.

For W-CDMA the level stability is similarly good as for the GSM modulation (see Fig. 6-2). The W-CDMA signal had a nominal level of -5.8 dBm. The frequency was set to 2 GHz.

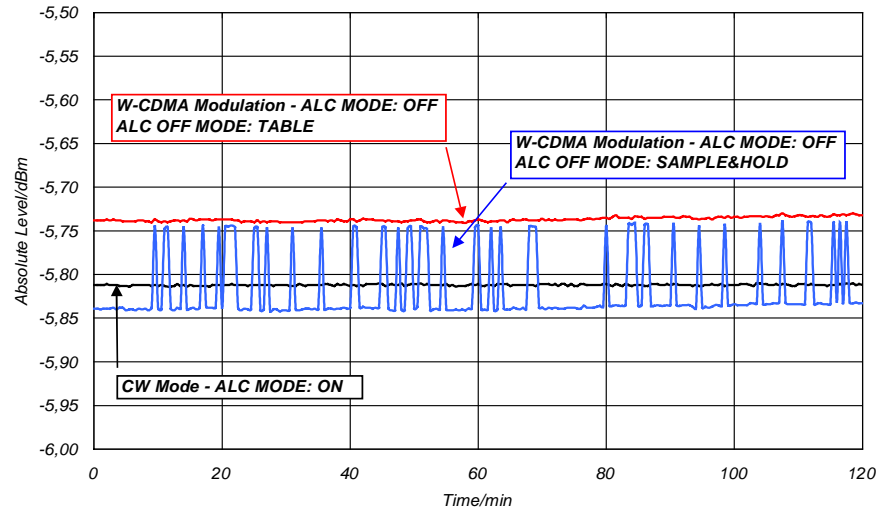

Fig. 6-2 The level stability of a W-CDMA signal. As a reference a CW signal has been measured first in order to show the level stability of the ALC circuit. The other two ALC modes operate with the W-CDMA modulated signal.

7 UCOR Mode in SMIQ for User Correction Functionality

One special feature of SMIQ is the possibility to set user defined correction values for the RF-level. In the LEVEL-UCOR menu the user can create and activate a list where level correction values are assigned to arbitrary RF frequencies.

UCOR mode arranges level correction values in a table similar to that in the ALC OFF MODE TABLE. In this mode correction values for the level are defined by the user. The major advantage is that a user can define level correction values in accordance with the user's demands and applications, such as compensating frequency response characteristics of a device under test.

Up to 10 lists can be compiled with a total of 160 list items. For frequencies which are not included in the table the level correction values are determined by means of linear interpolation.



To create, select and edit a UCOR list :

- Scroll to the LEVEL menu in the main menu.
- Select LEVEL and then UCOR with the select button.
- Scroll the highlight cursor to position SELECT LIST. Acknowledge with select.

A side window will pop up at the right hand corner.

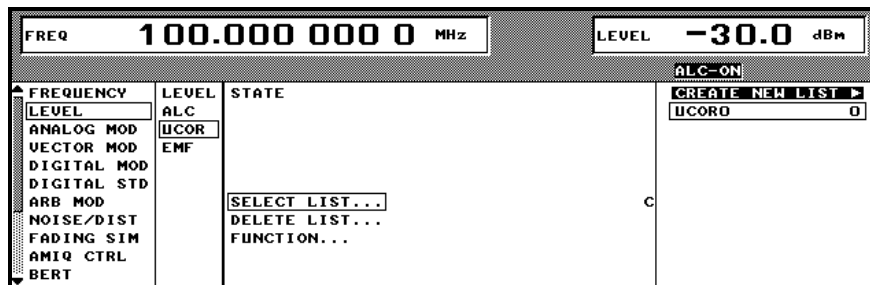

- Select CREATE LIST ►, press select

A new list will be created, displayed as UCOR0. The digit represents a counter from 0 ... 9. The list name can be seen next to CURRENT: in the SELECT LIST... submenu.

IEC/IEEE bus command:
: SOUR: CORR: CSET "UCOR0"

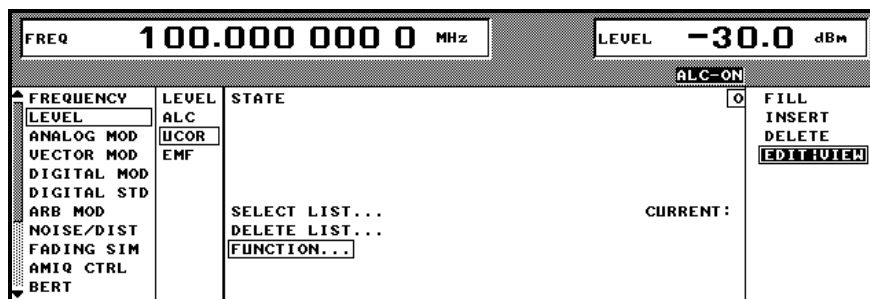

- Scroll down to FUNCTION..., press select

The highlight cursor will highlight the EDIT/VIEW list item. You can change the position by using the rotary knob to scroll to the desired edit function.

With the other list functions such as FILL, INSERT, DELETE in FUNCTIONS the user can either add or delete list items or entire list segments.

Level Accuracy and Electronic Level Settings

FREQ 100.000 000 0 MHz		LEVEL -30.0 dBm	
ALC-ON			
FREQUENCY	LEVEL	SELECT LIST...	CURRENT: UCORO
LEVEL	ALC	FUNCTION...	LEN 0000005
ANALOG MOD	UCOR	INDEX	
VECTOR MOD	EMF		
DIGITAL MOD		0000001	110.000 000 0 MHz
DIGITAL STD		0000002	120.000 000 0 MHz
ARB MOD		0000003	130.000 000 0 MHz
NOISE/DIST		0000004	140.000 000 0 MHz
FADING SIM		0000005	150.000 000 0 MHz
AMIQ CTRL		0000006	
BERT			
			CORRECTION
			-10.0 dB
			-7.5 dB
			-5.0 dB
			-2.5 dB
			0.0 dB

➤ Press select

A new side window will pop up as shown. The highlight cursor will be positioned at the first index line of the list. With the return button the highlight cursor will return to the function menu item.

➤ Press select again to enter a new frequency list item into the list.

➤ Acknowledge with the x1 button on the front panel.

The cursor will hop to the next position in the list where the level correction value can be entered. Again this entry needs to be acknowledged by a x1 keystroke. Proceed with the next list items as mentioned above.

IEC/IEEE bus command:
: SOUR: CORR: CSET: DATA:
: FREQ 100MHz, 110MHz, ...
: SOUR: CORR: CSET: DATA:
: POW -10dB, -7.5dB, ...

The IEC/IEEE bus command to activate the UCOR mode is:
: SOUR: CORR ON

FREQ 100.000 000 0 MHz		LEVEL -30.0 dBm	
		UCOR 0.0 dB	
ALC-ON			
FREQUENCY	LEVEL	STATE	OFF ON
LEVEL	ALC		
ANALOG MOD	UCOR		
VECTOR MOD	EMF		
DIGITAL MOD			
DIGITAL STD			
ARB MOD			
NOISE/DIST		SELECT LIST...	CURRENT: UCORO
FADING SIM		DELETE LIST...	
BERT		FUNCTION...	
LF OUTPUT			

In order to leave the menus press return twice and you are back at the UCOR main display. The user correction is active when the state is switched to ON.

8 References

W. Kraemer: Ein Economy-Generator der Extraklasse, Neues von Rohde & Schwarz **165**, 8, (1999)

Vector Signal Generator SMIQB, Operating Manual, PD 1125.5610.12, Rohde & Schwarz (2000)

Vector Signal Generator SMIQ, Service Manual, PD 1125.5610.24, Rohde & Schwarz (2000)

Vector Signal Generator SMIQ and Specification for Vector Signal Generator SMIQ, PD 757.2438.25, Rohde & Schwarz (2000)

9 Ordering Information

Vector Signal Generator

SMIQ02B	300 kHz to 2.2 GHz	1125.5555.02
SMIQ03B	300 kHz to 3.3 GHz	1125.5555.03
SMIQ04B	300 kHz to 4.4 GHz	1125.5555.04
SMIQ06B	300 kHz to 6.4 GHz	1125.5555.06

Options:

SMIQB11	Data Generator	1085.4502.04
SMIQB12	Memory Extension	1085.2800.04
SMIQB14	Fading Simulator	1085.4002.02
SMIQB15	Second Fading Simulator for two channel or 12 path fading	1085.4402.02
SMIQB17	Noise Generator and Distortion Simulator	1104.9000.02
SMIQB20	Modulation Coder	1125.5190.02
SMIQB21	BER Measurement	1125.5490.02
SMIQB45	Digital Standard WCDMA (3GPP)	1104.8232.02
SMIQB47	Low ACP for CDMA and WCDMA	1125.5090.02
SMIQB48	Extended Functions for WCDMA (3GPP)	1105.0587.02
SMIQB49	Extended Fading Functions for WCDMA (3GPP)	1105.1083.02



ROHDE & SCHWARZ

ROHDE & SCHWARZ GmbH & Co. KG · Mühldorfstraße 15 · D-81671 München · P.O.B 80 14 69 · D-81614 München · Telephone +49 89 4129 -0 · Fax +49 89 4129 - 13777 · Internet: <http://www.rohde-schwarz.com>

This application note and the supplied programs may only be used subject to the conditions of use set forth in the download area of the Rohde & Schwarz website.